

# POWERCON CORPORATION

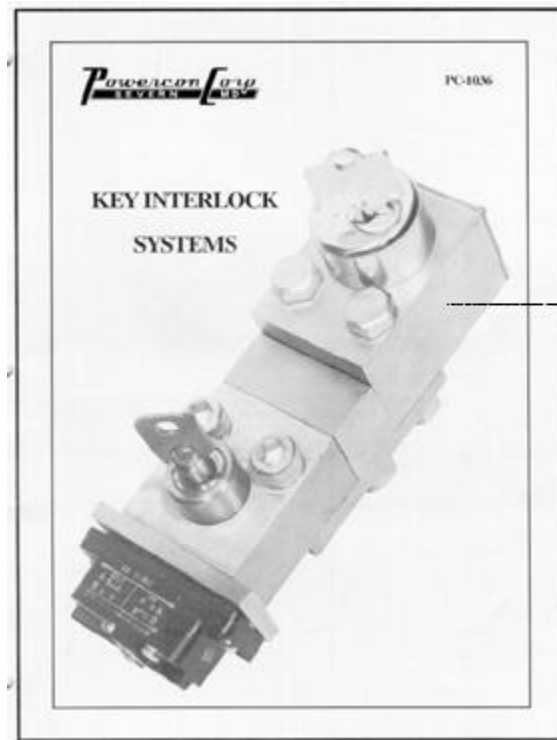

## KEY INTERLOCK SYSTEMS

**BROCHURE #PC-1036**

**ELECTRONIC VERSION CREATED: 6/30/96**

**Powercon Corporation  
P.O. Box 477  
1551 Florida Avenue  
Severn, Maryland 21144  
Baltimore: 410-551-6500  
Washington: 301-621-7400  
Fax: 410-551-8451  
<http://www.powerconcorp.com>  
email: [info@powerconcorp.com](mailto:info@powerconcorp.com)**

**WARNING  
IMPORTANT**

IT IS IMPERATIVE THAT YOU READ AND COMPLETELY UNDERSTAND THE WARNING LOCATED TO THE RIGHT OF THIS BLOCK FAILURE TO DO SO CAN RESULT IN DAMAGE TO PROPERTY.

**DANGER - HAZARDOUS VOLTAGE**

Do not remove covers, open doors or work on equipment unless power has been turned off and all circuits de-energized and disconnected. Disconnect, de-energize, lock-out and properly ground circuit(s) before working on this equipment. Use proper safety precautions when working on this equipment.

**WARNING  
IMPORTANT**

IT IS IMPERATIVE THAT YOU READ AND COMPLETELY UNDERSTAND THE WARNING LOCATED TO THE RIGHT OF THIS BLOCK FAILURE TO DO SO CAN RESULT IN DAMAGE TO PROPERTY.

**SAFETY**

All safety codes, safety standards and/or regulations as they may be applied to this type of equipment must be strictly adhered to. Before any adjustments, servicing, parts replacement or any other act is performed requiring any physical contact with the electrical components or wiring of this equipment, the power supply must be disconnected.

**WARNING  
IMPORTANT**

IT IS IMPERATIVE THAT YOU READ AND COMPLETELY UNDERSTAND THE WARNING LOCATED TO THE RIGHT OF THIS BLOCK FAILURE TO DO SO CAN RESULT IN DAMAGE TO PROPERTY.

**IN ADDITION, REFER TO:**

ANSI Z244.1-1982 : Personnel Protection Lockout/Tagout of Emergency Sources Minimum Safety Requirements

ANSI/NFPA 70E-1988: Electrical Safety Requirements for Employees Workplaces

ANSI/NFPA 70B-1987: Electrical Equipment Maintenance

Before any checking or maintenance of switchgear, after it has been installed - the following must be observed:

Only qualified persons may operate, inspect or maintain power switchgear. In addition to the personnel you may have who are qualified, others may be available from an experienced high voltage contractor or the utility servicing the installation. It is the responsibility of the purchaser, installer or ultimate user to insure that the warning signs are not removed and to make sure that all access doors and operating handles are securely locked when the gear is left unattended by qualified persons, even momentarily.

**WARNING  
IMPORTANT**

IT IS IMPERATIVE THAT YOU READ AND COMPLETELY UNDERSTAND THE WARNING LOCATED TO THE RIGHT OF THIS BLOCK FAILURE TO DO SO CAN RESULT IN DAMAGE TO PROPERTY.

Throughout this manual you will see warning blocks like the one located to the left. It is imperative that you read & completely understand the wording located below these blocks. Failure to do so can result in damage to property, personal injury or death.

## LIMITED WARRANTY

Powercon warrants that the equipment we deliver will be of the kind and quality described in the order or contract and will be free of defects in workmanship and material. Should any failure to conform to this warranty appear within one year after date of shipment, Powercon shall, upon prompt notification thereof and substantiation that the equipment has been stored, installed, operated and maintained in accordance with Powercon recommendations and standard industry practice, correct such nonconformities, at its option, either by repairing any defective part or parts or by supplying a repaired or replacement part or parts F.O.B. factory. However, if Powercon has installed the equipment or furnished field engineering services with respect to its installation, and provided such installation has not been delayed by the Purchaser, said one year shall run from the completion of the installation. The total warranty period shall not exceed 18 months from the date of shipment in any case.

In no event shall Powercon be responsible for providing working access to the defect, including the removal, disassembly, replacement or reinstallation of any equipment, materials, or structures to the extent necessary to permit Powercon to perform its warranty obligations, or transportation costs to and from the Powercon factory or repair facility. The conditions of any tests shall be mutually agreed upon and Powercon shall be notified of, and may be present at, all tests that may be made.

**THE WARRANTIES SET FORTH IN THIS PROVISION ARE EXCLUSIVE AND IN LIEU OF ALL OTHER WARRANTIES WHETHER STATUTORY, EXPRESS OR IMPLIED (INCLUDING ALL WARRANTIES OF MERCHANTABILITY AND FITNESS FOR PARTICULAR PURPOSE AND ALL WARRANTIES ARISING FROM COURSE OF DEALING OR USAGE OF TRADE), EXCEPT OF TITLE AND AGAINST PATENT INFRINGEMENT.** The remedies provided above are the Purchaser's sole remedies for any failure of Powercon to comply with its obligations. Correction of any nonconformity in the manner and for the period of time provided above shall constitute complete fulfillment of all the liabilities of Powercon whether the claims of the Purchaser are based in contract, in tort (including negligence) or otherwise with respect to or arising out of the equipment furnished hereunder.

## WARRANTY IMPLEMENTATIONS AND CONDITIONS

On those occasions where service help is required, the Powercon Corporation should be notified at once through its Service Department. No charges or expenses should be incurred except as authorized by the Corporation in writing. Making unauthorized corrections or doing unauthorized work voids this Warranty and renders reimbursement impossible.

At times, the Powercon Corporation may request labor and/or material services from you. At our option we will provide competent supervision who will authorize such services by signing the Time Sheets of the people involved. No reimbursement can be made without signed Time Sheets.

The services rendered must be of the type and quality satisfactory to the Powercon Corporation, and we reserve the right to reject any and all such services.

The above in no way prejudices the right of the Powercon Corporation to correct, as stipulated in the Warranty, any problems that may occur in equipment manufactured by the Powercon Corporation.

## FOREWORD

The warranty associated with this equipment is fully described with its implementation on Page ii. **It should be emphasized that unless approved by the Powercon Corporation no modification, alteration, additions, change or correction should be undertaken without such express authority provided in writing by representatives authorized to do so.**

This Instruction Book is furnished in "As Is" condition. No warranties expressed or implied, including warranties of fitness for a particular purpose, or merchantability, or warranties arising from course of dealing or usage of trade are made regarding the information, recommendations, descriptions, and safety notations contained herein. In no way will Powercon be responsible to the user in contract, in tort (including negligence), strict liability or otherwise for any direct special, indirect, incidental, or consequential damage or loss whatsoever, including but not limited to damage or loss of use of equipment, plant, or power system, cost of capital, loss of **profits** or revenues, cost of replacement power, additional expenses in the use of existing power facilities, or claims against the user by its customer resulting from the use of information, recommendations, descriptions, and safety notations contained herein.

The information, recommendations, descriptions, and safety notations in this document are based on Powercon's experience and judgement in respect to all of the subject matter contained herein. **This information must not be considered to be all inclusive or covering all contingencies.**

### WARNING QUALIFIED PERSONNEL ONLY

**WARNING  
IMPORTANT**  
IT IS IMPERATIVE THAT YOU READ  
AND COMPLETELY UNDERSTAND THE  
WARNING LOCATED TO THE RIGHT OF  
THIS BLOCK FAILURE TO DO SO CAN  
RESULT IN DAMAGE TO PROPERTY.

The equipment covered by this Instruction Book must be selected for a specific application and **it must be installed, operated and maintained by qualified persons who are thoroughly trained and who understand all of the hazards involved.** As with any electrical apparatus the thorough knowledge of the engineering safety, inspection, maintenance and repair techniques and familiarity with particular features of the apparatus involved is mandatory. This book does not provide sufficient instructions for inexperienced electricians **or** unqualified persons to do any work required including the handling, installation, testing, operation, inspection, maintenance, and repair. Refer to OSHA 29CFR Part 1910.399 (defines a qualified person).

### WARNING SAFETY GROUNDING TO BE DONE ON DE-ENERGIZED EQUIPMENT ONLY.

**WARNING  
IMPORTANT**  
IT IS IMPERATIVE THAT YOU READ  
AND COMPLETELY UNDERSTAND THE  
WARNING LOCATED TO THE RIGHT OF  
THIS BLOCK FAILURE TO DO SO CAN  
RESULT IN DAMAGE TO PROPERTY.

Before energizing the equipment and prior to any testing it is recommended that all circuits be safely grounded. Prior to any grounding whether it be for any testing, inspection, or maintenance procedures, assure that all safety precautions are taken. It is further recommended that an appropriate glow tube instrument that lights up and warns the worker when held in any alternating current field, indicating the presence of voltage, be used prior to grounding.

**Personnel doing such work should wear lineman's protective equipment in accordance with such equipment manufacturer's recommendations including but not limited to protective gloves, insulated sleeves, lineman's blankets, insulated helmets, face and eye protection that will assist in preventing injury if for any reason the equipment is grounded to an energized circuit. Every precaution should be taken to prevent such electrical grounding. Suitable grounding clamp leads should be used and safety grounding techniques employed. All such grounds must be removed after testing, inspection, or maintenance prior to energizing the equipment**

**The above in no way replaces the user's safety techniques or applicable safety codes, rules, or regulations.**

# KEY INTERLOCK SYSTEMS

## Application

An interlock systems is a series of key interlocks applied to associated equipment in such a manner, as to allow operation of the equipment only in prearranged sequence.

Interlocks are applicable to practically any field wherein human life or property is endangered, by an improper operation or improper sequence of operations.

Importance of Interlocking - Interlocks are an important element of the safety system. They are an important item in present day management because of the general desire to provide safe working conditions. Increasing safety legislation and a reduction of insurance rates when safety devices are used - are added incentives for the use of interlocks.

## Definition

An interlock is a device applied to, two or more moveable parts, preventing or allowing a movement of one part, only when another part is locked in it's predetermined position.

## Fundamental Requirements for Interlocks

There are three fundamental conditions to be met in a satisfactory interlock. It must be:

- Positive in Action

The interlock must normally make the controlled equipment absolutely inoperative at all times.

- Simple

The interlock must be a simple auxiliary device easily installed and also easily and quickly operated.

- Inexpensive

The interlock must be relatively inexpensive in proportion to the equipment protected so that it's use may be justified.

## General Information

The Powercon Key Interlock System is a simple, easy method of applying individual key interlock units and assemblies to electrical switchgear

assemblies requiring operation in a predetermined sequence.

## Construction of Interlocks and Assemblies

The interlock housings are made of high strength aluminum alloy and are designed for mounting with 3/8" bolts. The locking bolt is 5/8" diameter high strength aluminum alloy.

The lock is a special 7-pin tumbler lock, simple and rugged in construction. The lock housing is 7/8" diameter. The key has an ample finger grip of distinctive pattern. The lock number is stamped on the face of the lock and also on the key. It is a serial number applying to the lock combination and is used as a record for possible replacement and extension of systems.

All Powercon Key Interlocks can be provided with spst, spdt or dpdt switches - as required. Additional information on these interlocks is available upon request.

Multiple type interlocks can be provided for all of the Powercon Key Interlock Systems.

Optional plastic weatherproof covers of specially formulated materials are available. They are designed for close fitting requirements and to eliminate dust and moisture.

Special type interlocks can be designed to meet your requirements.

## Service and Maintenance

Under normal conditions, interlocks should not require any maintenance service. However, if service should be required contact Powercon Corporation.

In case of any defective interlocks or keys, the Powercon Corporation should be notified immediately. The following information should be readily available:

- Lock Number - From Face of Lock
- Shop Order Number, Switchgear Manufacturer's Name & Equipment Serial Number
- Specific Requirements on which interlock is applied
- Specific trouble experienced

## Type "PD" Interlock

The type "PD" or door interlock has two parts, a main body with one or more locks and a connecting block.

When the main body is separated from the connecting block, the locking bolt is retained in the withdrawn position. While it is retained, the key cannot turn in the lock, thus the key is always held in the lock whenever the two parts are separated.



**Photo 2:** Type "PD" Interlock with Catch Plate Mount & Cover



**Photo 1:** Type "PD" (Door) Interlock

When the door on which the interlock is mounted - is properly closed - the connecting block pins release the restrained operating bolt. The operating key can now be turned to extend the locking bolt into the connecting block. After the bolt is extended, the operating key may be removed.

The lock housing and connecting block of the type "PD" interlock are machined from high strength aluminum bar stock and are designed for mounting with two (2) 3/8" diameter fillister head bolts. The locking bolt is machined from 5/8" diameter solid high strength aluminum alloy.

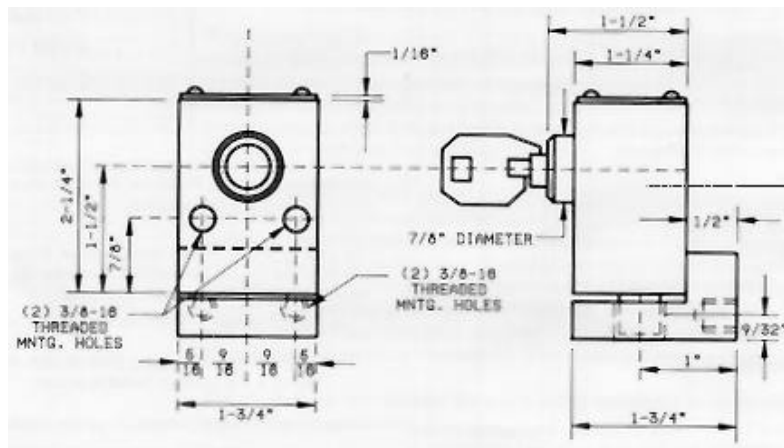

**Figure 1:** Type "PD" Interlock

## Type "PF" Interlock

The type "PF" interlock is designed for surface mounting with two (2) 3/8" fillister head bolts. The mounting bolt heads are predrilled for attaching sealing wires.

Projecting from the end of the interlock housing is the locking bolt. This locking bolt is machined from high strength aluminum (5/8" diameter) and has a total movement of 7/16" standard. Bolt movement of 3/4" can be supplied on special order. The interlock can be supplied with a zero (0) bolt projection or as required. Bolt projection is determined when the locking bolt is withdrawn and must be specified on all orders.

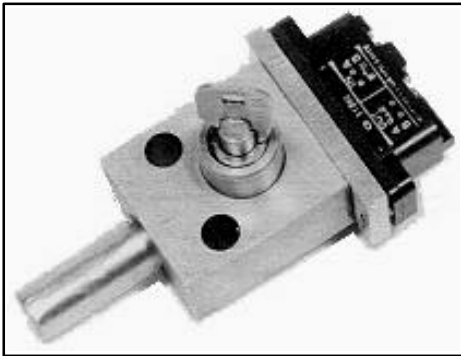

Photo 3: Type "PF" Interlock with Microswitch Cover

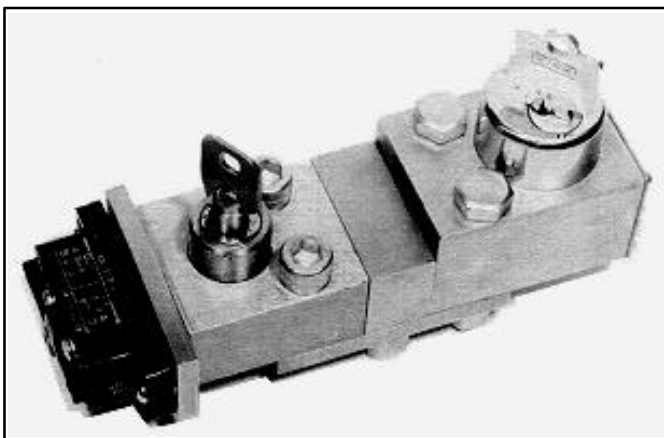

Photo 4: Type "PF" Interlock with Microswitch & Kirk Lock



Photo 5: Type "PF" Interlock (Electric Only)

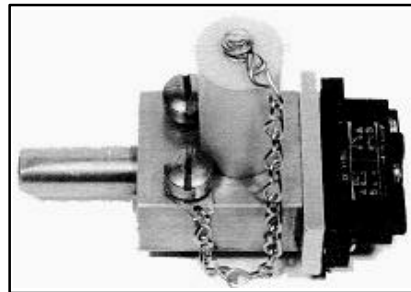

Photo 6: Type "PF" Interlock with Microswitch & Chain

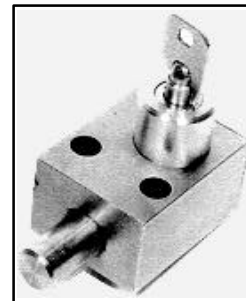

Photo 7: Type "PF" Interlock (Special -Offset Cylinder)

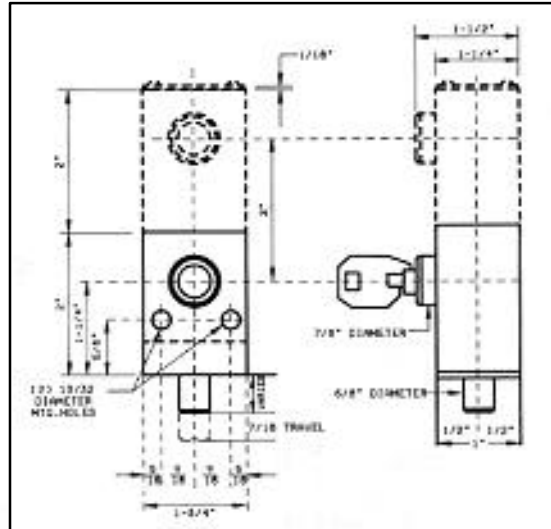

Figure 2. Type "PF" Interlock - 7/16" Travel

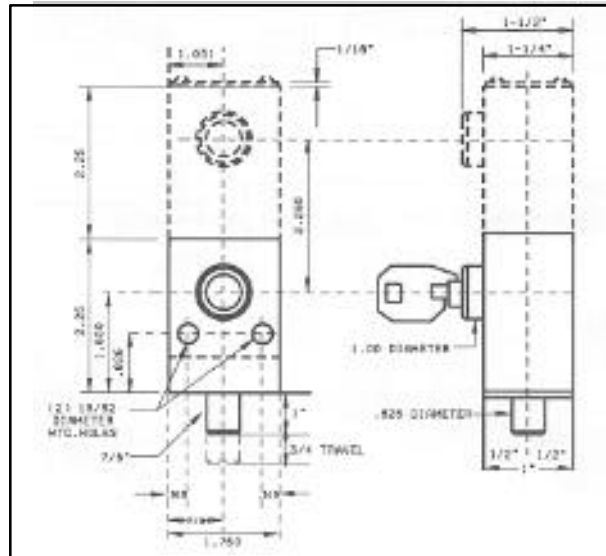

Figure 3. Type "PF" Interlock - 3/4" Travel



## Type "PC" Interlock

The type "PC" interlock is a single lock used in an interlock system with any of the other Powercon Interlocks.

It is suitable for mounting on a flat plate and various bolt extensions can be provided upon request, such as shown in Photo 9.



Photo 8: Type "PC" Interlock - Standard

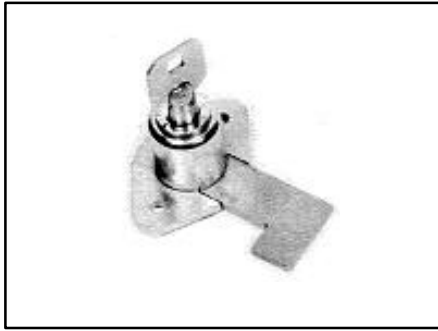
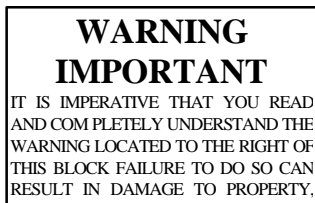

Photo 9: Type "PC" Interlock - Special Bolt

## Duplicate Key(s)



**A DUPLICATE KEY IS FOR INSTALLATION ONLY. DESTROY ALL DUPLICATE KEYS BEFORE THE INTERLOCKED EQUIPMENT IS ENERGIZED. FAILURE TO DESTROY DUPLICATE KEY(S), CAN DEFEAT THE INTERLOCK SYSTEM AND PROVIDE ACCESS TO EQUIPMENT OR PERMIT OPERATING ERRORS THAT CAN RESULT IN PROPERTY DAMAGE, INJURY, OR DEATH.**

Duplicate keys may be ordered but an order for duplicate key(s) requires Powercon to clarify our position regarding Powercon Key Interlock Systems. These systems operate in a predetermined sequence. Duplicate key(s) provide a means to defeat this sequential operation. Accordingly, before we can comply with an order, we must have your acknowledgement of the potential hazards arising from the use of a duplicate key(s) and your agreement to defend, indemnify and hold harmless Powercon Corporation for any claim, demand, suit, loss or damage recovered from Powercon Corporation, by reason of any damage to property including loss of use thereof-, or injury, including death sustained by any person arising out of the use of a duplicate key(s) to defeat the system.

Duplicate key(s) orders will not be entered without an authorization form being completed and signed by authorized personnel.

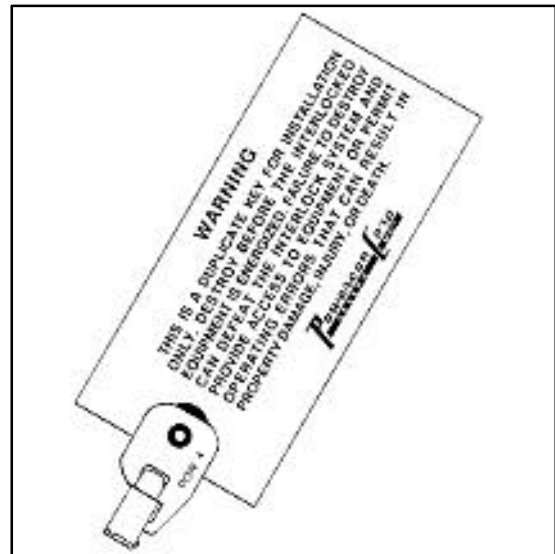

Figure 4 Duplicate Key

Powercon Corporation  
1551 Florida Ave.  
P.O. Box 477  
Severn, Maryland 21144  
Tel: 301-551-6500  
Fax: 301-551-8451

\_\_\_\_\_  
\_\_\_\_\_  
\_\_\_\_\_  
Attn: \_\_\_\_\_

Reference:  
PO: \_\_\_\_\_  
SO: \_\_\_\_\_  
Duplicate Key(s): \_\_\_\_\_  
Additional Keylock(s): \_\_\_\_\_

Dear Sir:

Your order for duplicate key(s), additional keylocks for the expansion of existing interlock system, and/or replacement keylocks, requires up to clarify the our position regarding Powercon Key Interlock Systems.

These systems operate in a predetermined sequence. Duplicate key(s) provide a means to defeat this sequential operation. Accordingly, before we can comply with your order, we must have your acknowledgement of the potential hazards arising from the use of a duplicate key(s) for existing interlocking systems including additions to same associated with expansion/additions of key interlocks, and your agreement to defend, indemnify and hold harmless Powercon Corporation for any claim, demand, suit, loss or damage recovered from Powercon Corporation, by reason of any damage to property including loss of use thereof; or injurv including death sustained by any person arising out of the use of a duplicate key(s) to defeat the system.

Please indicate your agreement by signing and returning this letter. Upon receipt of this letter bearing your signature, we will enter your order for prompt shipment.

Acknowledged and Agreed:  
By: \_\_\_\_\_  
Title: \_\_\_\_\_  
Date: \_\_\_\_\_

Sincerely Yours,  
  
POWERCON CORPORATION



**Optional Item: Key Interlock Scheme**

Reference Figure 7 - available upon special order. Available in various sizes and materials. For further information, contact Powercon Corporation, Sales Department.

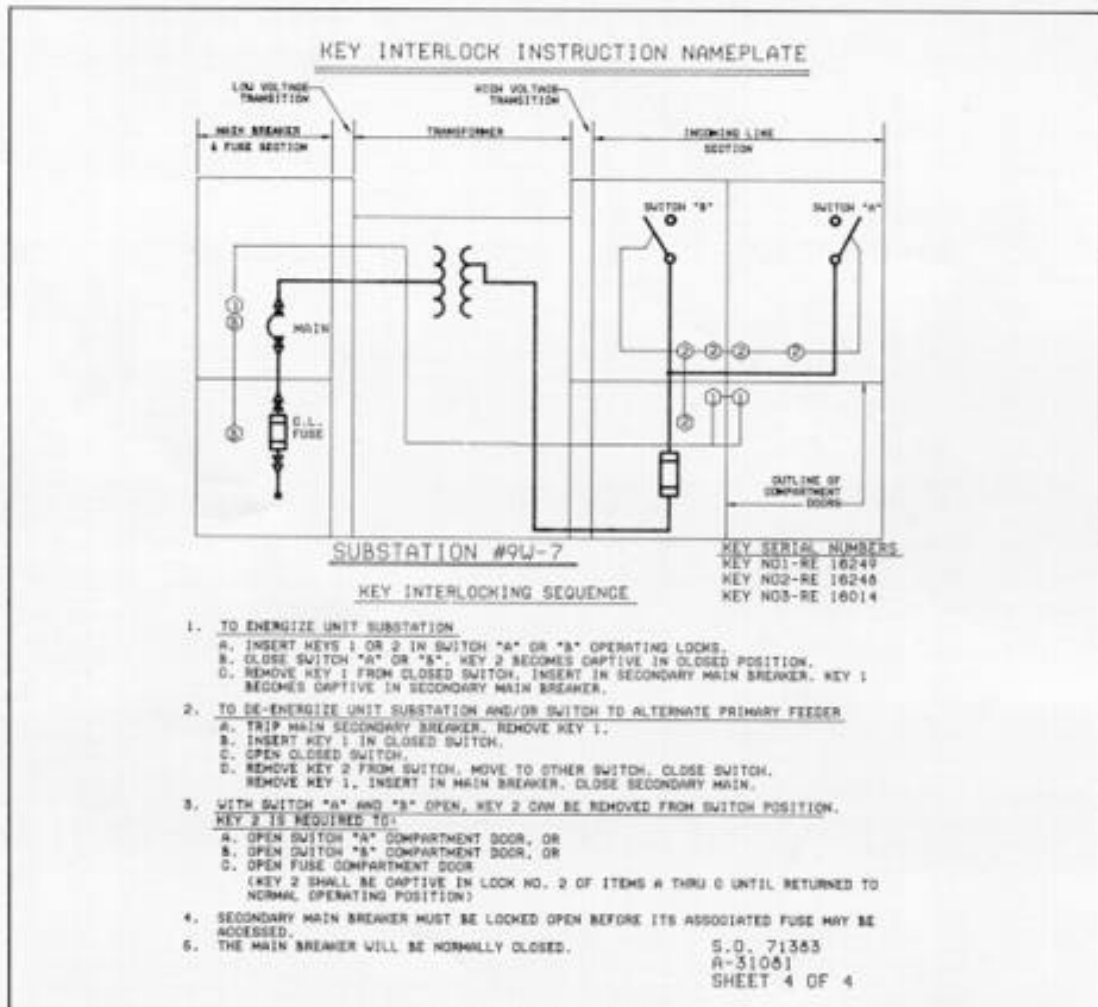

Figure 7: Typical Key Interlock Scheme



Baltimore: 410-551-6500  
 Washington: 301-621-7400  
 TOLL FREE: 1-800-638-5055  
 FAX#: 410-551-8451

P.O. Box 477  
 1551 Florida Avenue  
 Severn, Maryland 21144